

ECLIPSE

UP - DOWN DIAMETRO 130



CARATTERISTICHE TECNICHE PRODOTTO

Apparecchio di illuminazione a sospensione in alluminio estruso diametro 130 cm, Verniciato a polveri di colore bianco completo di diffusore in PMMA opale.

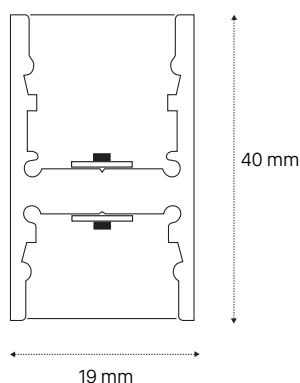

UP - DOWN

150 Watt
Sorgente W/mt
23 - 14

CRI 90
LUMEN 6.327
4000 K

DIFFUSORE IN PMMA
COLORE BIANCO
DURATA 50.000 ORE
TEMPERATURA -20 +55 °C

GARANZIA 5 ANNI

IP20 CE

