

ISAAC PLUS

DIFFUSORE PRISMATIZZATO



CARATTERISTICHE TECNICHE PRODOTTO

Lampada ad emissione diretta - indiretta, composta da estruso di alluminio, diffusore in Policarbonato opale e alimentatore incorporato. Finitura standard bianco opaco, colori personalizzati su richiesta.

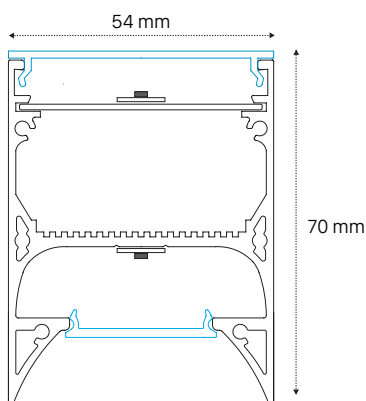

LUCE UP
11W/mt CRI 90

LUCE DOWN
26W/mt CRI 90

LUMEN TOTALI/mt 2.700
3000 K

DIFFUSORE IN POLICARBONATO
COLORE BIANCO
MAC ADAM 3
DURATA 50.000 ORE
TEMPERATURA -20 +55 °C

GARANZIA 5 ANNI

IP20  

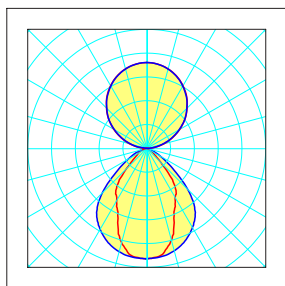

ACCESSORI DISPONIBILI

STAFFA PER SOSPENSIONE



STAFFA PER PARETE



GIUNTO LINEARE

