

ISAAC BAR

DIFFUSORE OPALE



CARATTERISTICHE TECNICHE PRODOTTO

Lampada ad emissione diretta, composta da estruso di alluminio e diffusore in policarbonato opale.
Alimentatore incorporato. Finitura standard bianco opaco verniciata a polveri, colori personalizzati su richiesta.

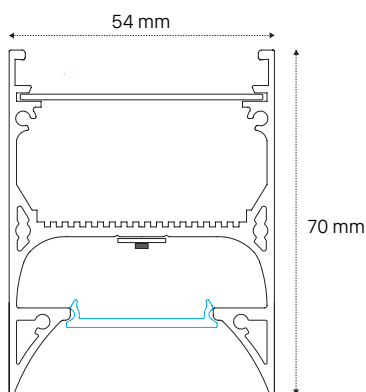

16W/mt
CRI 90
LUMEN/mt 1.000
4000 K

DIFFUSORE IN POLICARBONATO
COLORE BIANCO
MAC ADAM 3
DURATA 50.000 ORE
TEMPERATURA -20 +55 °C

GARANZIA 5 ANNI

IP20  

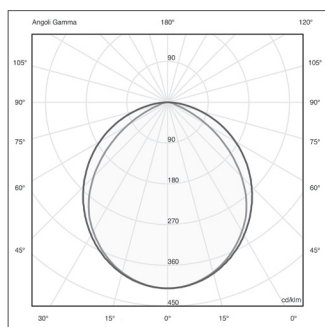

ACCESSORI DISPONIBILI

STAFFA PER SOSPENSIONE



STAFFA PER PLAFONE



STAFFA PER PARETE



GIUNTO LINEARE

