

RAINBOW

DIFFUSORE OPALE



CARATTERISTICHE TECNICHE PRODOTTO

Apparecchio LED per incasso cartongesso.

Corpo lampada in estruso di alluminio verniciato a polveri di colore bianco o nero.

Tolleranza di colore minima Mac Adam 3, durata Led 50.000 ore con rimanenti 90% del flusso luminoso iniziale.

Apparecchio con diffusore opale. Comandi disponibili ON-OFF, DALI.

Prodotto garantito 5 anni.

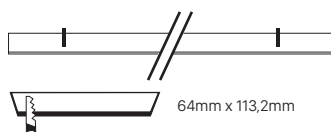
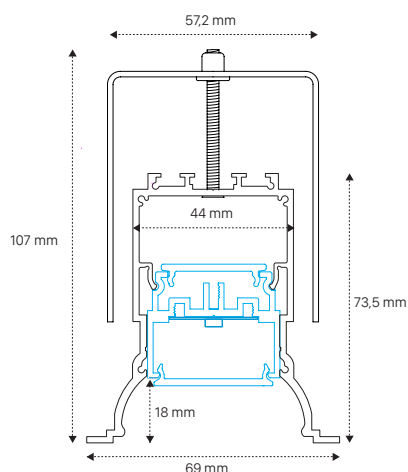

26 Watt/mt CRI 90
LUMEN/mt 1.472
3000 K

MAC ADAM 3
350 mA
DURATA 50.000 ORE
TEMPERATURA -20 +55 °C

GARANZIA 5 ANNI

IP20  

DISPONIBILE IN DUE COLORAZIONI STANDARD: BIANCO - NERO

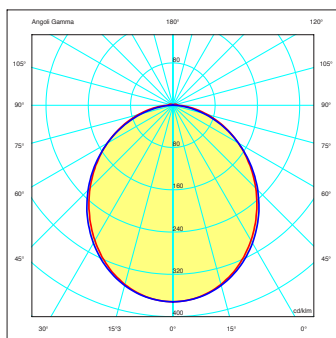

STAFFA PER INCASSO

