

GIOS

LENTE BATWING

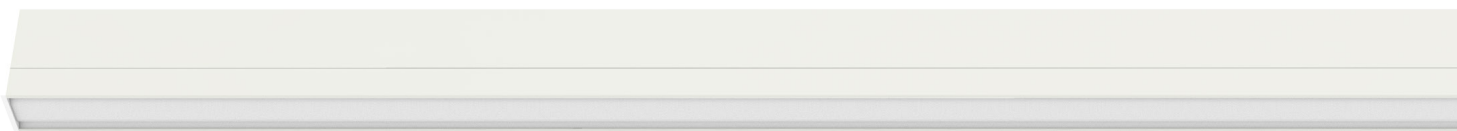

CARATTERISTICHE TECNICHE PRODOTTO

Corpo lampada in estruso di alluminio verniciato a polveri di colore bianco o nero.
Tolleranza di colore minima Mac Adam 3, durata Led 50.000 ore con rimanenti 90% del flusso luminoso iniziale.
Apparecchio con lente batwing, resa cromatica CRI>80 o CRI>90, temperatura di colore 3000 o 4000 K.
Comandi disponibili ON-OFF, DALI.

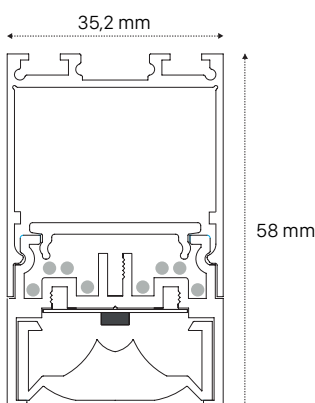

14 Watt/mt
CRI 80
LUMEN 1.674
4000K

MAC ADAM 3
350 mA
DURATA 50.000 ORE
TEMPERATURA -20 +55 °C

GARANZIA 5 ANNI

IP20  

DISPONIBILE IN DUE COLORAZIONI STANDARD: BIANCO - NERO

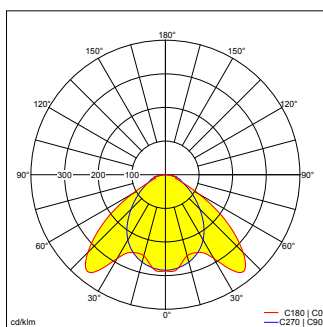

STAFFA PERSOSPENSIONE

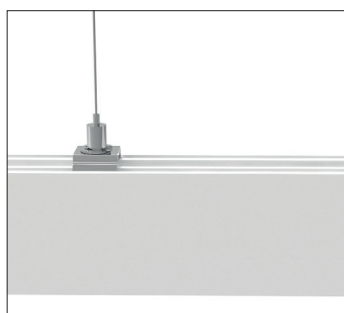

STAFFA PER PLAFONE

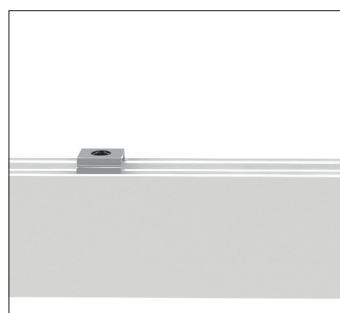

Alimentatore e Kit di fissaggio sono inclusi.