

RAINBOW 224

DIFFUSORE OPALE



CARATTERISTICHE TECNICHE PRODOTTO

Apparecchio LED per incasso cartongesso.

Corpo lampada in estruso di alluminio verniciato a polveri di colore bianco o nero.

Tolleranza di colore minima Mac Adam 3, durata Led 50.000 ore con rimanenti 90% del flusso luminoso iniziale.

Apparecchio con diffusore opale, resa cromatica CRI>80 o CRI>90, temperatura di colore 3000 o 4000 K.

Comandi disponibili ON-OFF, DALI, ON-OFF + EM, DALI + EM.

Prodotto garantito 5 anni.

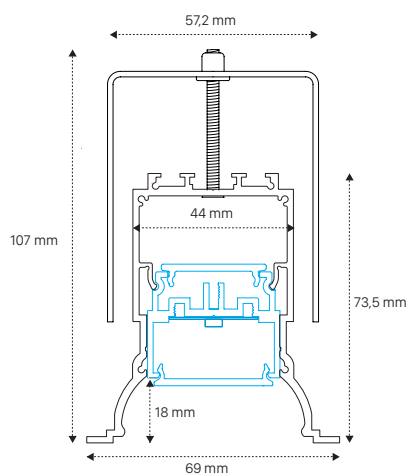

225,6 Cm



225,6 cm

68W CRI 80

LUMEN 5.881

69W CRI 90

LUMEN 5.086

KELVIN 3000 - 4000
MAC ADAM 3
350 mA
DURATA 50.000 ORE
TEMPERATURA -20 +55 °C

GARANZIA 5 ANNI

IP20  

DISPONIBILE IN DUE COLORAZIONI STANDARD: BIANCO - NERO

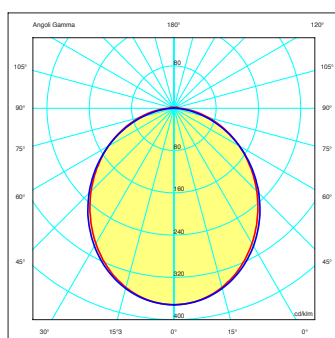

STAFFA PER INCASSO

